

لنساعد الطفلة على رمي الكرة إلى سلة حرف ب ؟

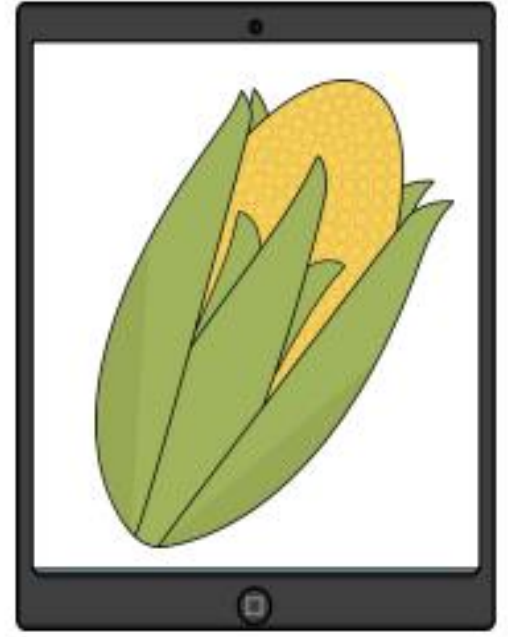

أن يختار الطفل حرف ب

لنساعد الطفل على اختيار الابداد الذي يحتوي على صورة تبدأ بحرف ج ؟

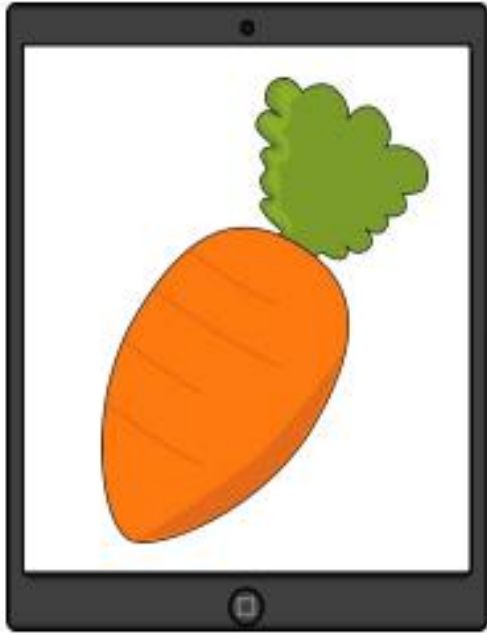

أن يختار الطفل صورة تبدأ بحرف ج

لنساعد الطفل على اختيار الطريق إلى صورة تبدأ بحرف س ؟

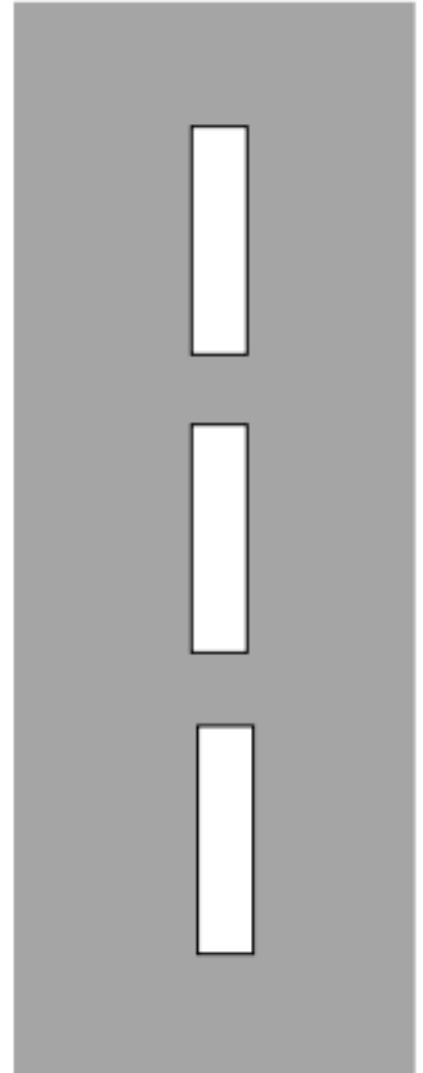
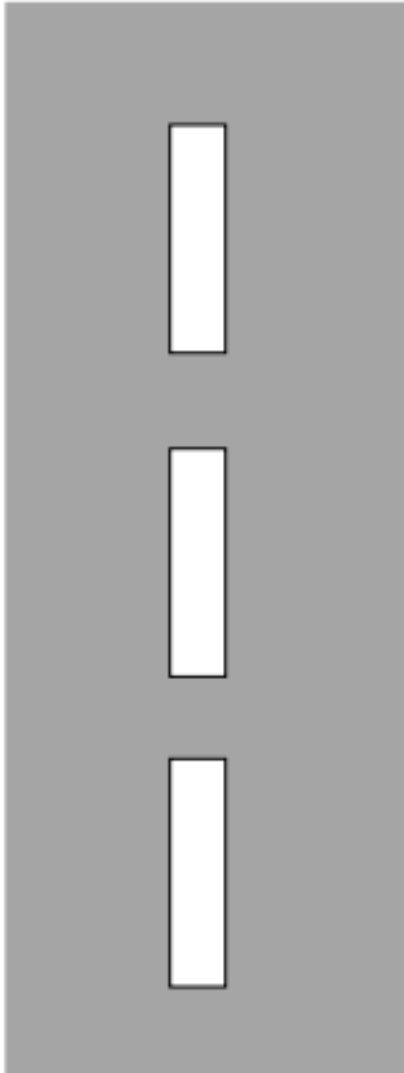

أن يختار الطفل صورة تبدأ بحرف س

لنساعد الطفلة على اختيار الطريق الصحيح إلى حرف ش ؟

ت

ش



لنساعد الطفلة على اختيار حرف ض؟

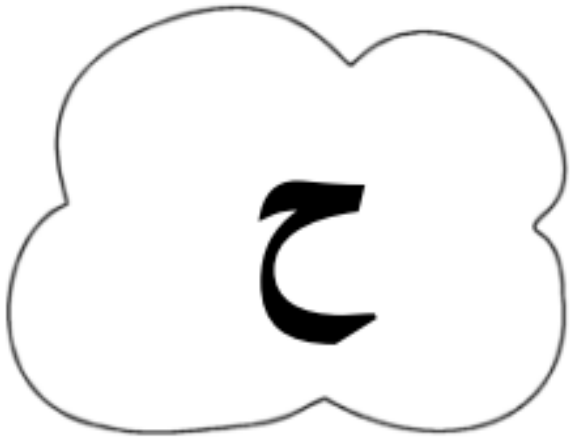

أن يختار الطفل حرف ض

لنساعد الطفلة على رمي الكرة إلى سلة حرف ف ؟



أن يختار الطفل حرف ف

لنساعد الطفل على التقاط صورة تبدأ بحرف ك ؟

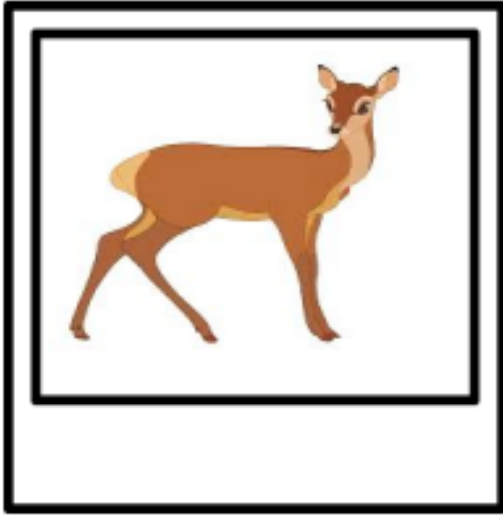

أن يختار الطفل صورة تبدأ بحرف ك

لنساعد الطفل على اختيار الطريق إلى صورة تبدأ بحرف و ؟

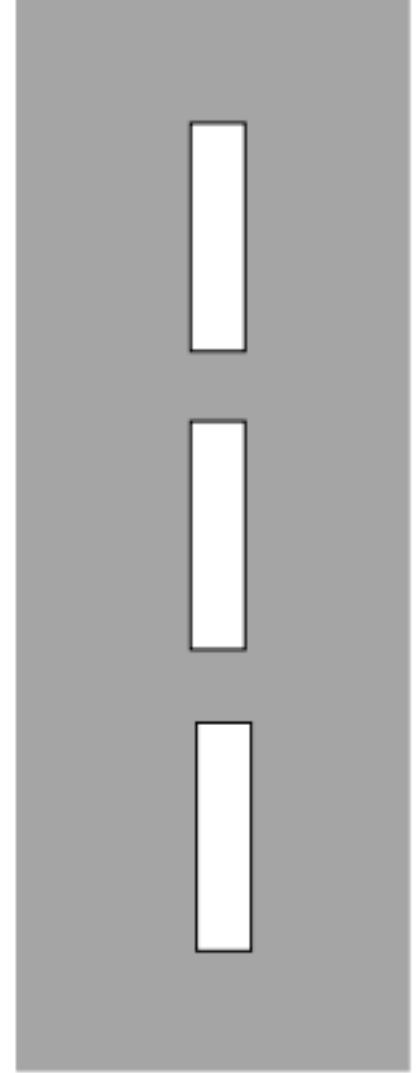
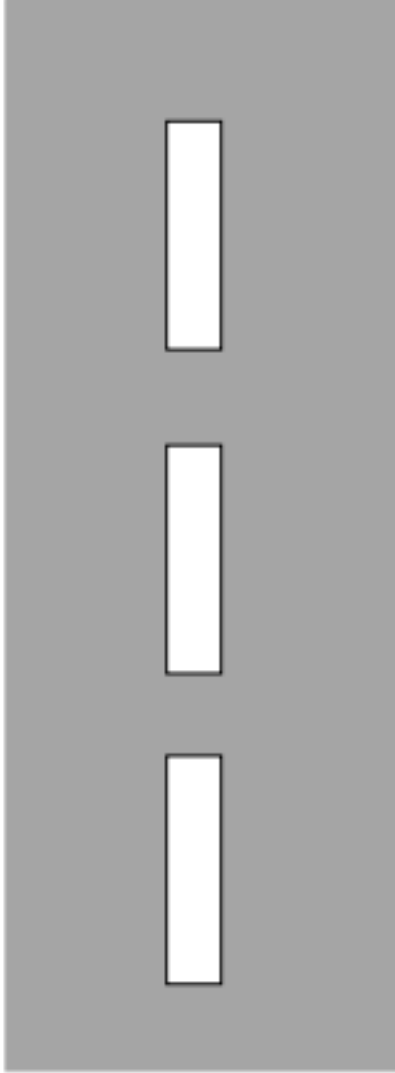

أن يختار الطفل صورة تبدأ بحرف م

لنساعد الطفلة على اختيار الطريق الصحيح إلى حرف ي؟

ن

ي



أن يختار الطفل حرف ي

لنساعد الطفلة على اختيار الطريق الصحيح إلى حرف أ ؟

ن

أ



لنساعد الطفل على اختيار الطريق إلى صورة تبدأ بحرف ت ؟

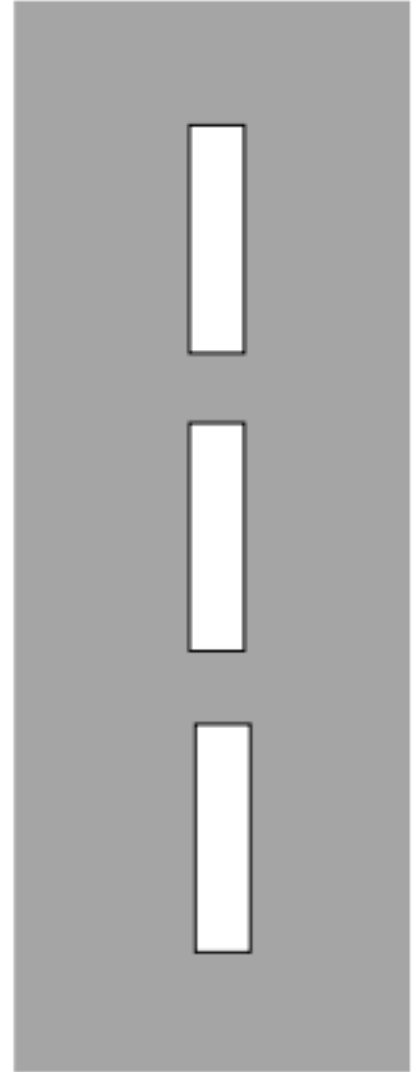
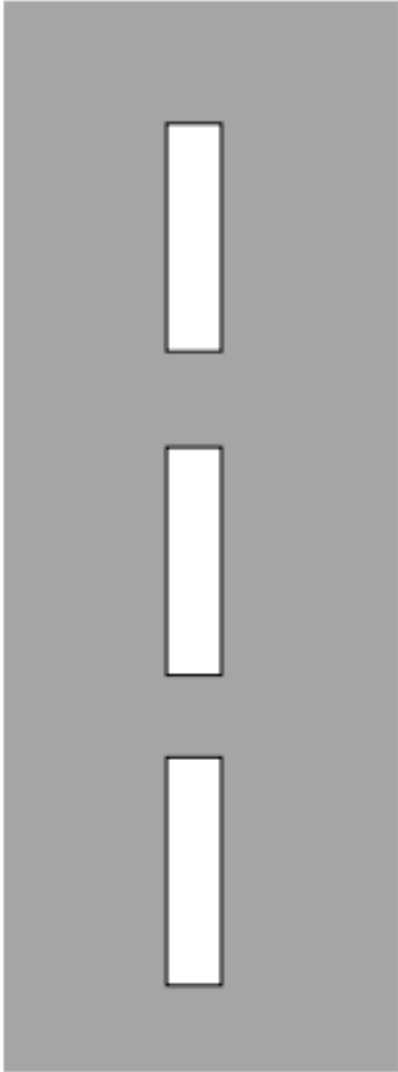

أن يختار الطفل صورة تبدأ بحرف ت

لنساعد الطفل على التقاط صورة تبدأ بحرف ث ؟

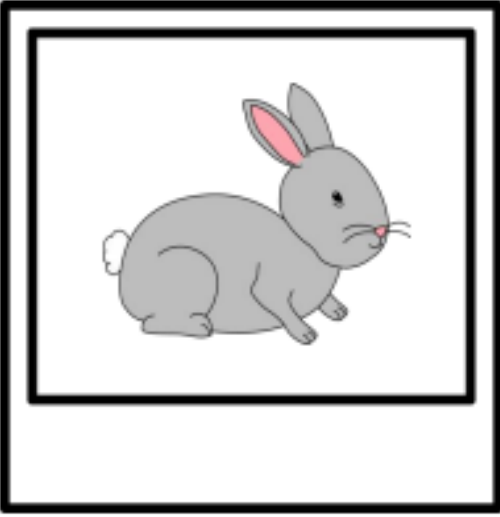

أن يختار الطفل صورة تبدأ بحرف ث

لنساعد الطفلة على رمي الكرة إلى سلة حرف ج ؟



أن يختار الطفل حرف ج

لنساعد الطفلة على اختيار الطريق الصحيح إلى حرف ر؟

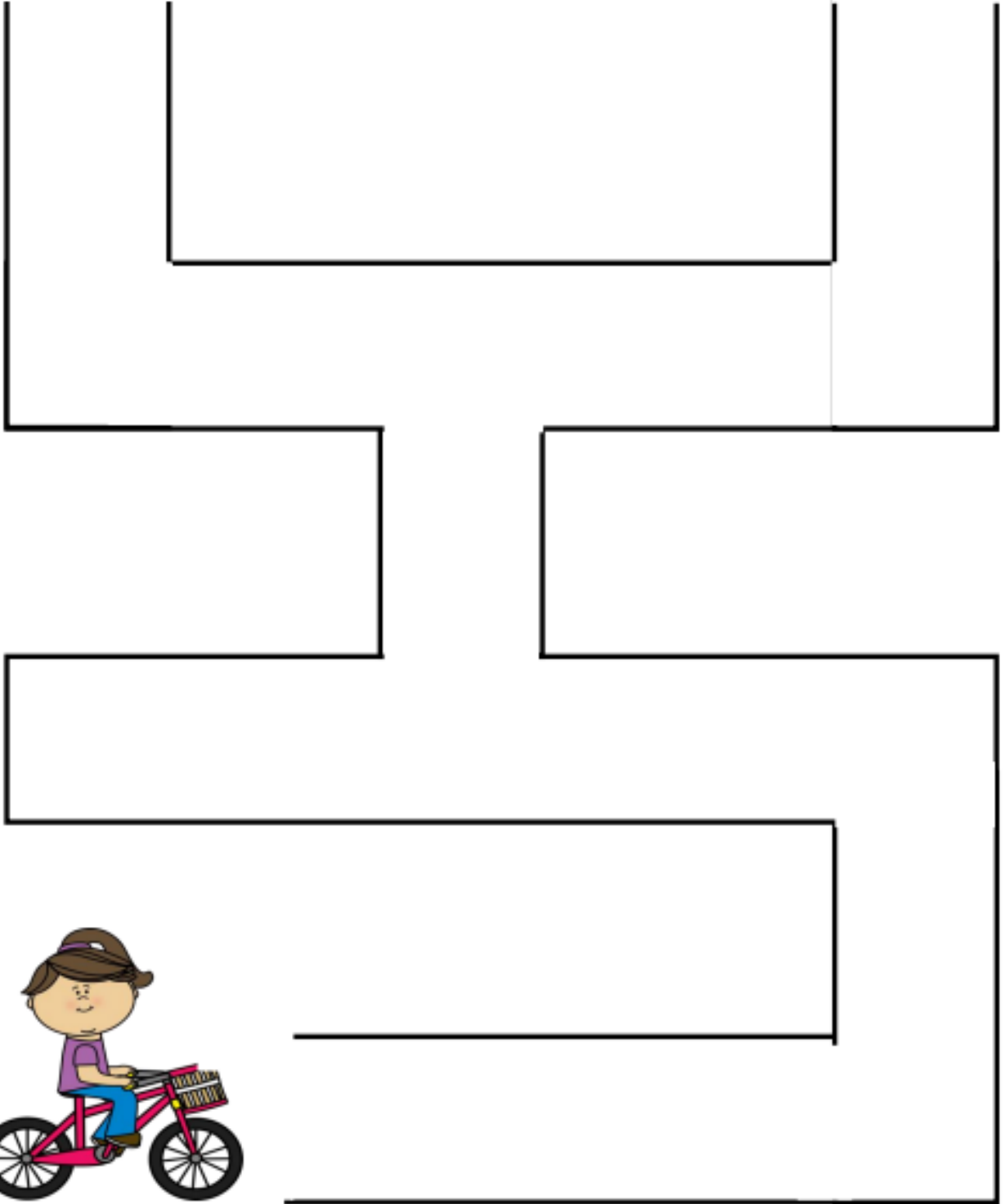

لنساعد الطفل على كتابة حرف ز ؟

ز	ز
ز	ز

لنساعد الطفل على اختيار الابداد الذي يحتوي على صورة تبدأ بحرف ص؟

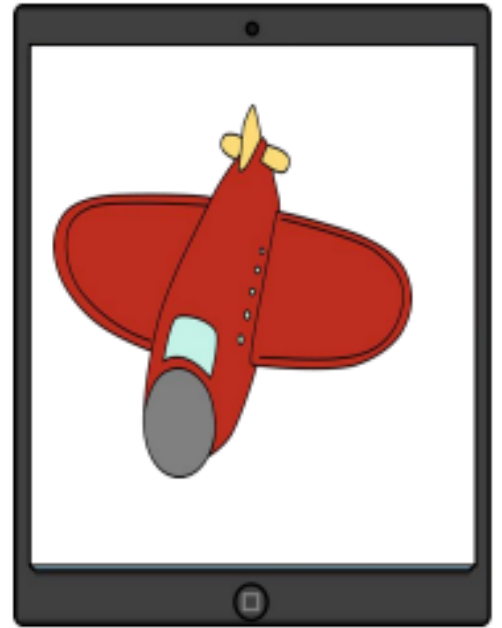
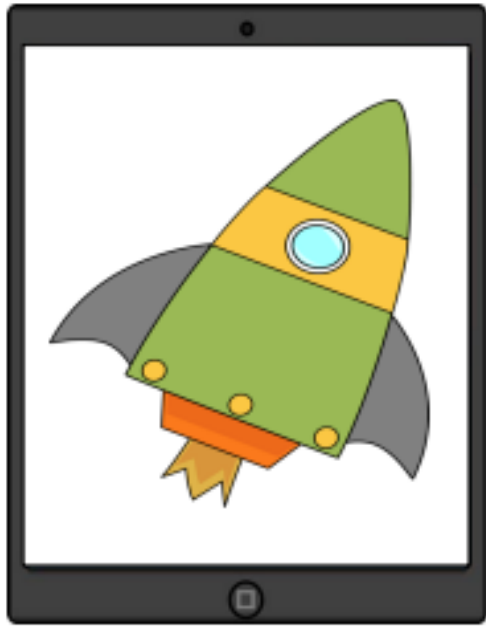

أن يختار الطفل صورة تبدأ بحرف ص

لنساعد الطفلة على رمي الكرة إلى سلة حرف ظ ؟



أن يختار الطفل حرف ظ

لنساعد الطفل على كتابة حرف ع ؟

ع	ع
ع	ع

لنساعد الطفل على التقاط صورة تبدأ بحرف غ؟

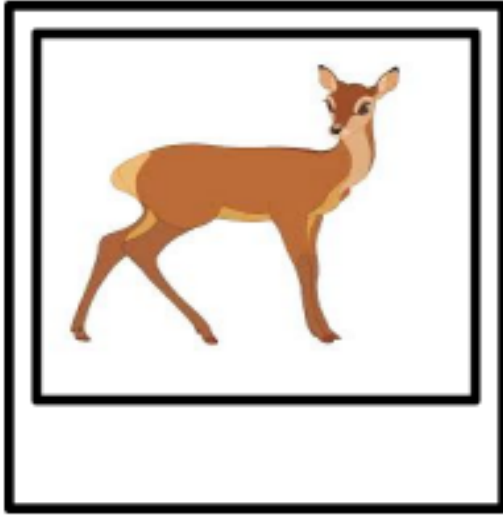

أن يختار الطفل صورة تبدأ بحرف غ

لنساعد الطفلة على اختيار حرف ق؟

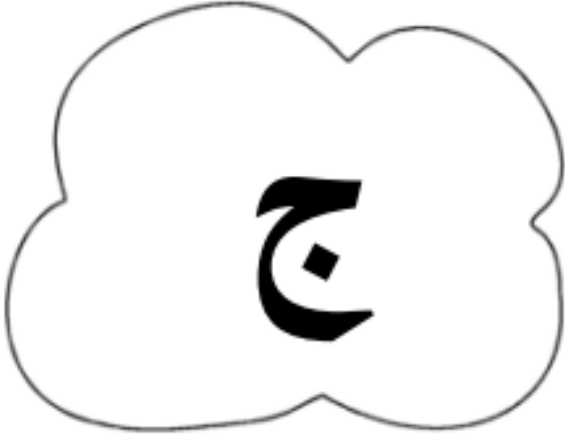

أن يختار الطفل حرف ق

لنساعد الطفل على اختيار الایباد الذي يحتوي على صورة تبدأ بحرف ل ؟

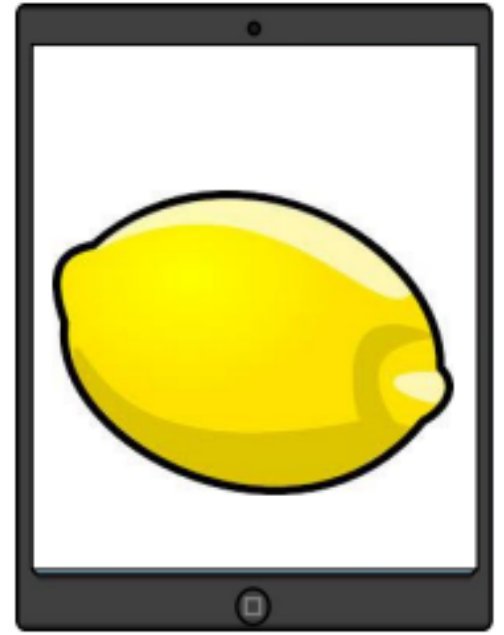

ان يختار الطفل صورة تبدأ بحرف ل

لنساعد الطفل على كتابة حرف م ؟

م	م
م	م

أن يكتب الطفل حرف م

لنساعد الطفلة على اختيار الطريق الصحيح إلى حرف ن؟

ن

ل













أن يختار الطفل حرف ن

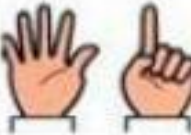

أعد كتابة العدد

٥	٤	٣	٢	١
١٠	٩	٨	٧	٦

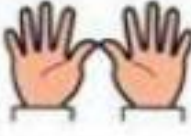
أكتب العدد المناسب للصوره.....

			
			
			
			
			

صل الصورة بالرقم الصحيح:-

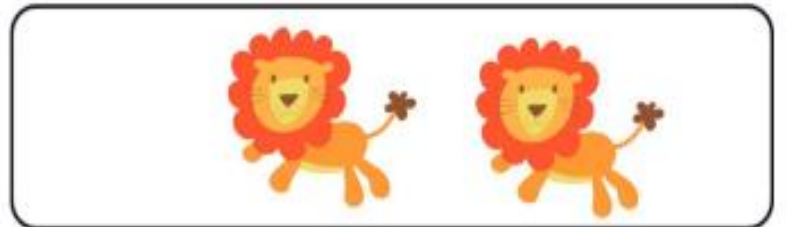
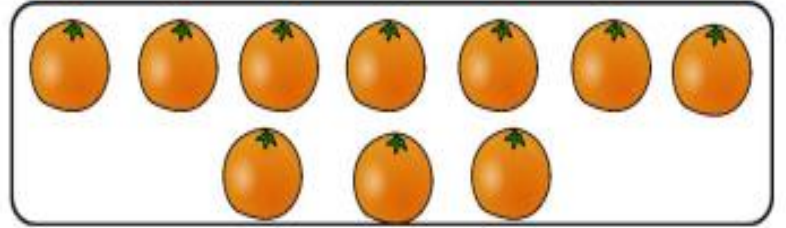
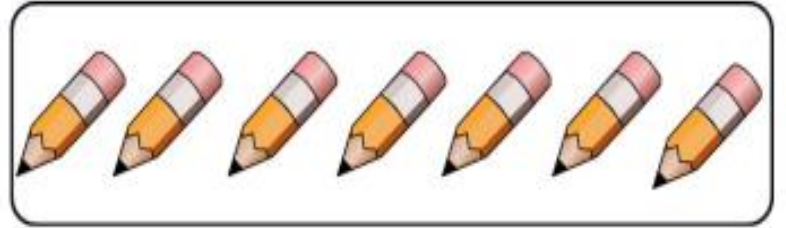
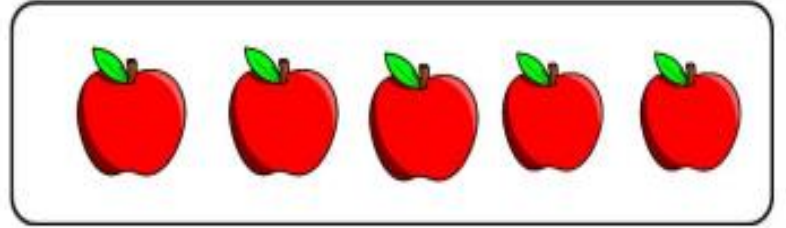
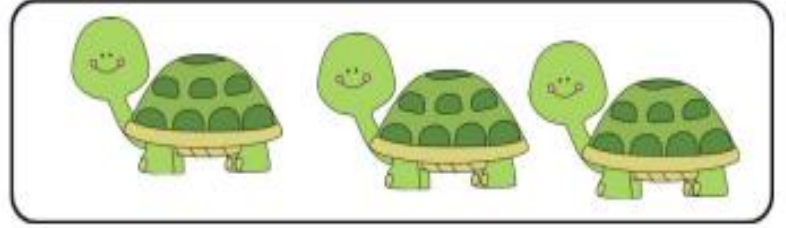
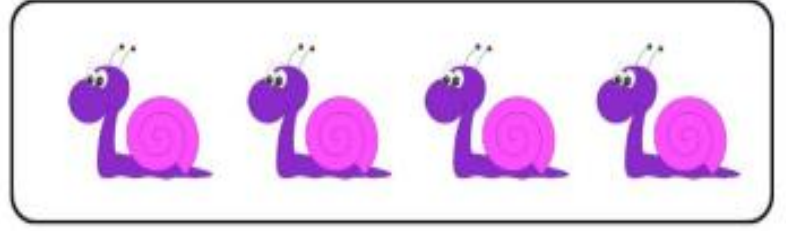



ارسم خمس شمعات
ثم لون الكيكة

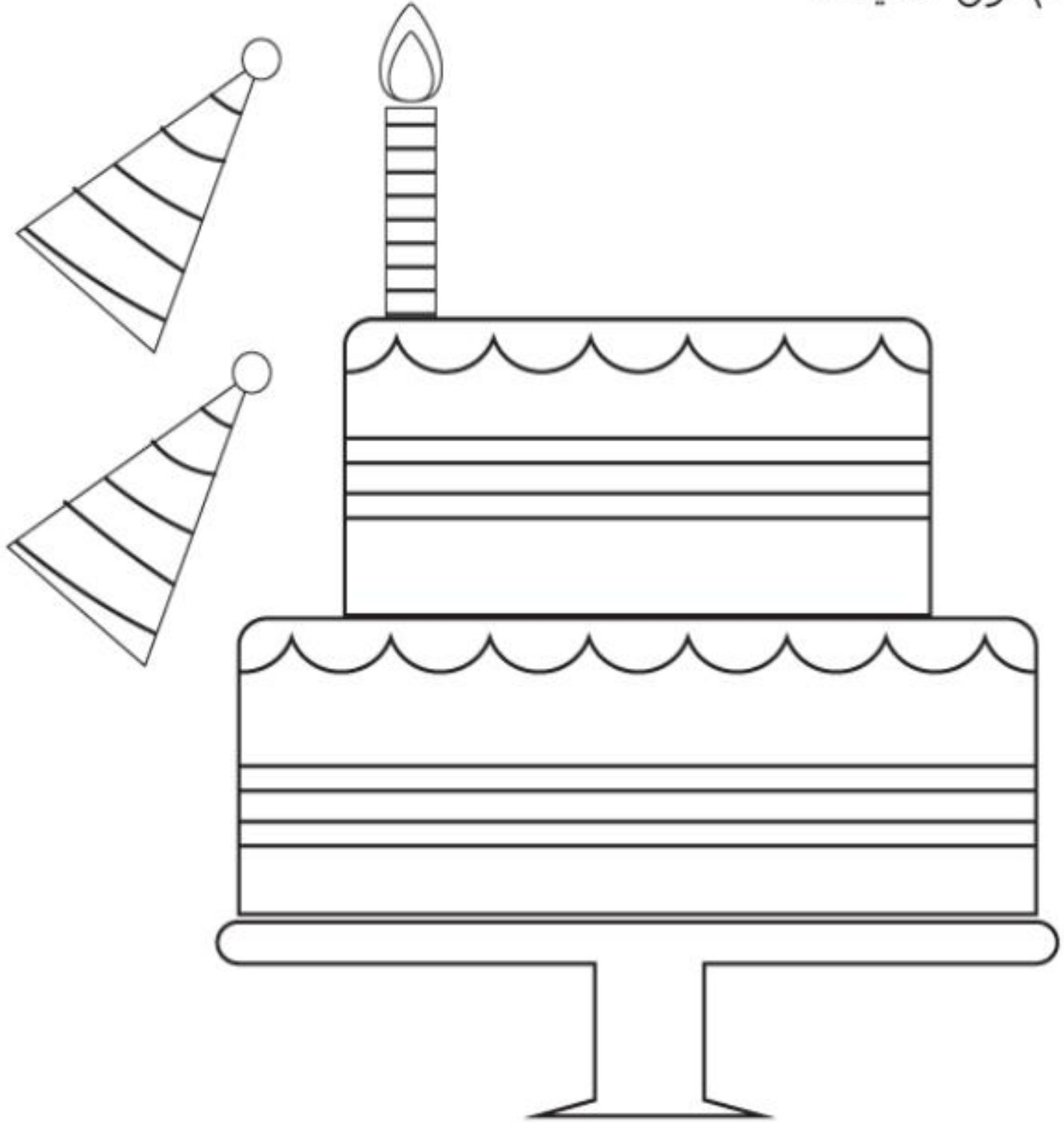

صل كل حيوان باللون المناسب له:



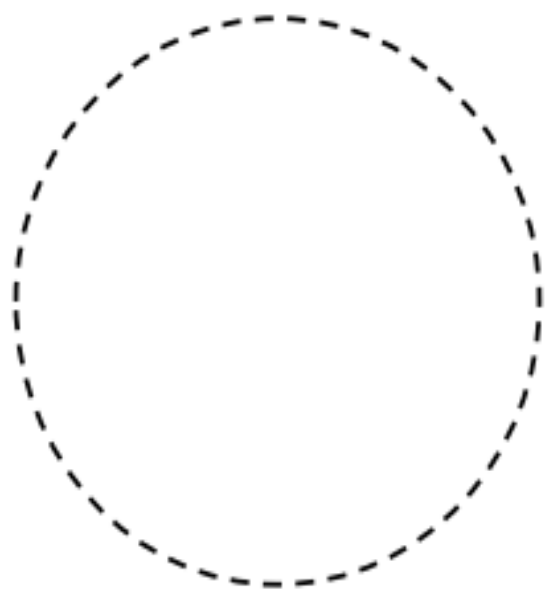

دائرة



مربع

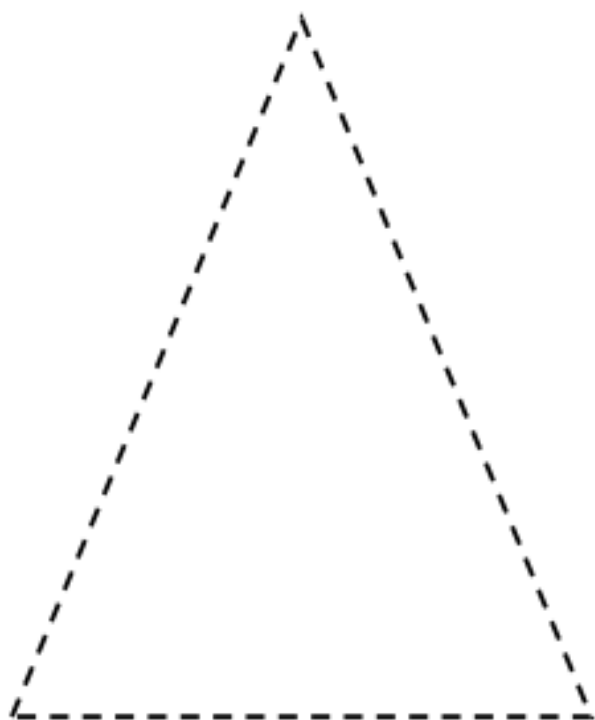

مثلث



مستطيل



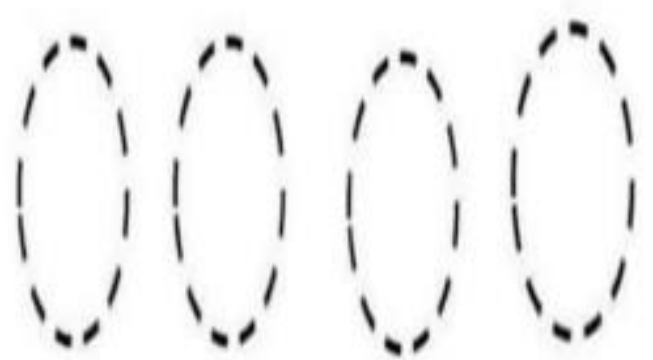
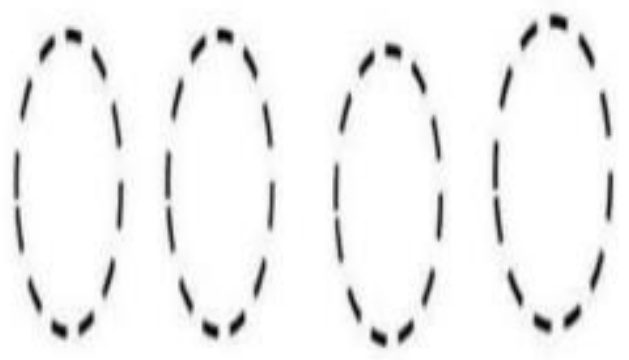

شكراً لك يا صغيري البطل على حلك
لقد قمت بعمل جميل بالمحاولة والحل وأريد منك أن تتعلم المزيد من
المهارات لتصبح شخصاً مهماً في المستقبل وتفيد المجتمع وتساعد
الناس وتسعد والديك

أتمنى لك التوفيق والنجاح دائماً

شكراً لك يا صغيرتي البطلة على حلك
لقد قمتي بعمل جميل بالمحاولة والحل وأريد منك أن تتعلمي المزيد
من المهارات لتصبحي شخصاً مهماً في المستقبل وتفيدين المجتمع
وتساعدين الناس وتسعدين والديك

أتمنى لك التوفيق والنجاح دائماً

